



PNEUMATIC COIL NAILER

RN-45E / CN-50E

CN-57E / CN-565

CN-70E / CN-83E



INSTRUCTION MANUAL

WARNING

READ AND UNDERSTAND THIS MANUAL BEFORE OPERATING THE TOOL

IMPROPER USE OF THIS TOOL WILL RESULT IN DEATH OR SERIOUS INJURY

KEEP THIS MANUAL WITH THE TOOL FOR FUTURE REFERENCE.

PNEUMATIC COIL NAILER

**RN-45E / CN-50E / CN-57E
CN-565 / CN-70E / CN-83E**

INSTRUCTION MANUAL

INDEX

SAFETY INSTRUCTIONS	2
SPECIFICATIONS	6
COMPRESSED AIR SYSTEM	9
CONNECTION TO THE COMPRESSOR	9
TOOL OPERATION	10
TOOL MAINTENANCE	13
STORING.....	13
TROUBLESHOOTING/REPAIRS	14

WARNING 

READ AND UNDERSTAND THIS MANUAL BEFORE OPERATING THE TOOL.

IMPROPER USE OF THIS TOOL WILL RESULT IN DEATH OR SERIOUS INJURY.

KEEP THIS MANUAL WITH THE TOOL FOR FUTURE REFERENCE.

SAFETY INSTRUCTIONS

WARNING



READ ALL INSTRUCTIONS. Do not attempt to operate the tool until you read and understand all safety precautions and manual instructions. Ensure to follow the warnings and instructions to avoid serious personal injury or property damage.

PRECAUTION AND INSTRUCTION ON USING THE TOOL



WEAR EYE PROTECTION EQUIPMENT. Due to possibility of a fastener flying up which caused by improper operating of the tool, the user and/or operator must ensure that suitable eye protection equipment is worn, such as glasses or goggles. Eye protection equipment must conform to the requirement of the American National Standards Institute, ANSI Z87.1 and provide both frontal and side protection.

WEAR EAR PROTECTION EQUIPMENT. High level of noise may expose in some environments which can lead to hearing damage. The employer and user should ensure that any necessary hearing protection is provided and used by the operator and others in the work area.



NEVER USE ANY POWER SOURCE OTHER THAN AIR COMPRESSOR. Absolutely do not use oxygen, combustible gases, or bottled gases as a power source for the tool as tool may explode, possibly causing injury.



NEVER EXCEED THE PROPER AIR PRESSURE RANGE. Do not exceed maximum permissible operating pressure 8 bar (120 p.s.i.) as tool may cause injury. Never connect the tool to air pressure which potentially exceeds 14 bar (200 p.s.i.) as the tool may burst.

SAFETY INSTRUCTIONS

WARNING



KEEP AWAY FROM A FLAMMABLE SUBSTANCE. Never use gasoline or other flammable liquids to clean the tool. Never use the tool near a flammable substance. Vapor in the tool will ignite by a spark as causing explosion.

NEVER USE A WRONG FITTING. Do not use a check valve or any other fitting that allows air to remain in the tool which will be able to drive a fastener even after the air line is disconnected, possibly causing injury.

NEVER TOUCH THE TRIGGER ONLY IF INTENDING TO DRIVE A FASTENER. If you do not intend to drive a fastener into the work, never touch the trigger whenever the air supply is connected to the tool. Avoid carrying the tool with the trigger pulled.



NEVER POINT TOOL NOSE TOWARD YOURSELF AND OTHER PERSONNEL. Ensure the tool nose is not pointed toward people when connecting and disconnecting the air source, loading and unloading the fasteners or similar actions at all time.

NEVER DRIVE FASTENERS CLOSE TO THE EDGE OF THE WORK. Do not drive fasteners near the edge of the work which is likely to split and the fastener could fly free and hit someone to cause injury.

SAFETY INSTRUCTIONS

WARNING

NEVER DRIVE FASTENER ON TOP OF OTHERS. Do not drive fastener on top of other fasteners which fasteners may be deflected possibly causing injury.

NEVER DRIVE FASTENER AT OVER STEEP ANGLE. Do not drive fastener with the tool at an overly steep angle as this may cause deflection of fasteners which could cause injury.

NEVER CARRY THE TOOL BY HOSE. Never carry the tool by the hose or pull the hose to move the tool. Only carry the tool by the handle (grip).

KEEP AWAY YOUR HAND AND BODY FROM THE NOSE OUTLET. Whenever loading or driving fasteners, never place your hand or any part of body in nose outlet of the tool. Keep away any part of your body to avoid dangerous caused by mistake.

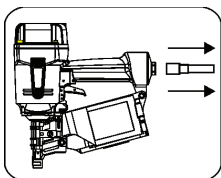

DISCONNECT THE TOOL FROM AIR SUPPLY BEFORE CLEARING JAMS, PERFORMING REPAIRS AND DURING NON-OPERATION.

SAFETY INSTRUCTIONS

WARNING

USE EXTRA CARE WHEN EVALUATING PROBLEM TOOLS.

UNLOADING THE FASTENERS AFTER FINISHING WORK.

CHECK CONTACT ARM MECHANISM AND TRIGGER FREQUENTLY.

NO HOSE PLAY, RESPECT THE TOOL AS A WORKING IMPLEMENT, WORK SAFELY.

ALWAYS ASSUME THAT THE TOOL CONTAINS FASTENERS.

DO NOT USE THE TOOL AS A HAMMER.

ONLY USE THE TOOL FOR THE PURPOSE IT WAS DESIGNED

KEEP THE TOOL IN A DRY PLACE OUT OF THE REACH OF CHILDREN.

DO NOT MODIFY THE TOOL FROM THE ORIGINAL DESIGN OR FUNCTION.

SPECIFICATIONS

TOOLS



Model	WEIGHT	HEIGHT	WIDTH	LENGTH	LOADING CAPACITY
RN-45E	2.6 kg 5.7 lb	283mm 11 1/8"	118mm 4 5/8"	269mm 10 5/8"	120 pcs
CN-50E	2.18 kg 4.8 lb	116mm 4 3/5"	275mm 10.8"	265mm 10.4"	400 pcs
CN-57E	2.5 kg 5.5 lb	285mm 11 7/32"	135mm 5 5/16"	285mm 11 7/32"	300-400 pcs
CN-565	2.68 kg 5.9 lb	320mm 12 3/5"	130mm 5"	280mm 11"	Wire: 250-400 pcs Plastic sheet: 200 pcs
CN-70E	3.62 kg 7.96 lb	318mm 12 1/2"	125mm 4 7/8"	320mm 12 5/8"	225-300 pcs
CN-83E	3.7 kg 8.2 lb	349mm 13 3/4"	129mm 5 1/16"	313mm 12 5/16"	225-300 pcs

FASTENERS



Model	NAIL LENGTH	SHANK DIAMETER
RN-45E	19-45mm, 3/4~1 3/4"	3.05mm, .120"
CN-50E	25-50mm, 1~2"	2.1mm, .083"
CN-57E	25-57mm, 1~2 1/4"	2.1-2.3mm, .083"-.090"
CN-565	Wire: 45-65mm, 1 3/4~2 1/2" Plastic sheet: 32-65mm, 1 1/4~2 1/2"	2.3-2.5mm, .090"-.099"
CN-70E	45-70mm, 1 3/4~2 3/4"	2.5-2.9mm, .099"-.113"
CN-83E	50-83mm, 2-3 1/4"	2.5-3.3mm, .099"-.131"

SPECIFICATIONS

SHANK TYPE

SMOOTH	RING	SCREW
		

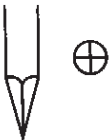
NAIL TIP TYPE

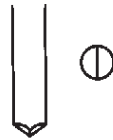
DIAMOND	BLUNT DIAMOND	BLUNT CHISEL
		

AIR SUPPLY SYSTEM

RECOMMENDED OPERATING PRESSURE	70 ~ 100 p.s.i. 5 ~ 7 bar
MAXIMUM PERMISSIBLE OPERATING PRESSURE	120 p.s.i. / 8 bar DO NOT EXCEED!!
AIR CONSUMPTION	1.48 L at 90 p.s.i. (6bar) operating pressure
AIR INLET AND FITTINGS	N.P.T. 1/4" or 3/8" connector P.T. 1/4" or 3/8" connector
OPTIONAL ACCESSORIES	Goggles, Hex. Bar wrench, Lubricant

SPECIFICATIONS

TECHNICAL DATA

NOISE CHARACTERISTIC VALUES

In accordance with EN12549:1999, Noise test code for fastener driving tools, to determine and record these values.

A-weighted single-event sound pressure level: $L_{WA, 1S, d} =$

RN-45E	CN-50E	CN-565	CN-57E	CN-70E	CN-83E
95.96dBA	95.56dBA	96.7dBA	94.84dBA	99.57dBA	101.20dBA

A-weighted single-event surface sound pressure level: $L_{PA, 1S, d} =$

RN-45E	CN-50E	CN-565	CN-57E	CN-70E	CN-83E
89.12dBA	89.20dBA	88.7dBA	88.06dBA	90.56dBA	94.02dBA

!! At The Workplace, Always Wear Hearing Protection Equipment !!

VIBRATION CHARACTERISTIC VALUES

In accordance with ISO 8662-11, Hand-held portable power tools - Measurement of vibrations at the handle - Part II: Fastener driving tools, to determine and record these values.

Weighted root mean square acceleration = $3.34m/s^2$

APPLICATIONS

- Wooden pallets / boxes, Crates, Paneling, Decking, Sheathing, Fencing, Siding

NAME OF PARTS

- ① Exhaust Port (cover)
- ② Cylinder Cap
- ③ Body
- ④ Nose
- ⑤ Contact Arm
- ⑥ Grip
- ⑦ Trigger
- ⑧ Air Inlet
- ⑨ Magazine

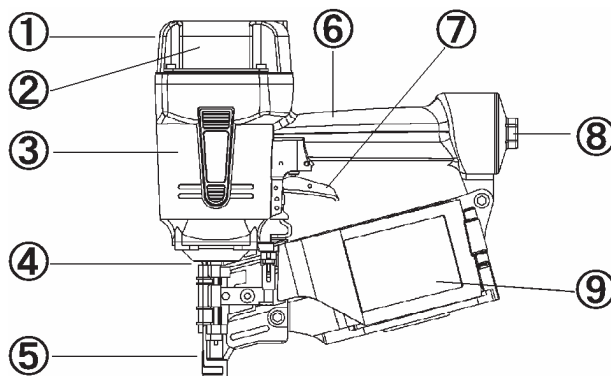

COMPRESSED AIR SYSTEM

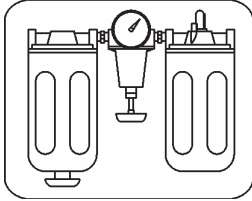

USE 3-PIECE AIRSET (filter, regulator, oiler)

Oiler can provide oil circulation through tool. Filter can remove liquid and impurities, which can rust or wear internal parts of the tool.

Oil level in the oiler and the filter daily must be checked and drained when necessary to increase the efficiency and prolong the life of tool.

When the air pressure in the line system exceeds the maximum permissible operating pressure for the tool, a pressure reducing valve must additionally be fitted to the safety valve in the downstream supply line.

Compressed air pipelines should be set as slanted line and the air compressor should be the highest point. Easily accessible water separators should be installed at the lowest point.

CONNECTION TO THE COMPRESSOR

The following illustration shows the correct method of connecting the tool to the compressed air system, which will increase the efficiency and life of the tool.

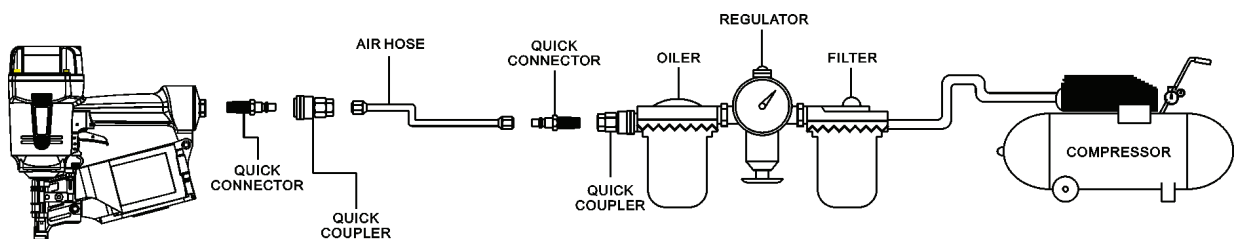

For better performance, install a 3/8" quick connector with an inside diameter of .315" on your tool and a 3/8" quick coupler on the air hose.

TOOL OPERATION

BEFORE OPERATING THE TOOL

1. READ AND UNDERSTAND THE PRECAUTIONS AND WARNINGS CONTAINED IN THIS MANUAL.
2. REFER TO “TOOL SPECIFICATIONS” IN THIS MANUAL TO IDENTIFY THE OPERATING SYSTEM ON YOUR TOOL.

TOOL OPERATION CHECK

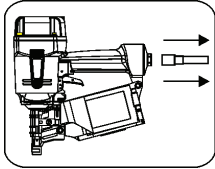

1. Disconnect the air supply from the tool.
2. Empty the magazine.

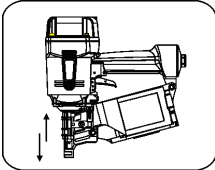

3. Check operation of the contact arm & trigger if moving smoothly

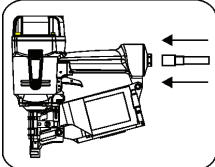

4. Connect the air supply to the tool.

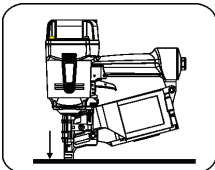

5. Depress the contact arm against the work-piece without pulling the trigger. (The tool must not cycle)

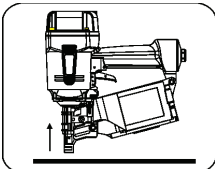

6. Hold the tool clear of the work-piece. The contact arm should return to its original position. Pull the trigger. (The tool must not cycle)

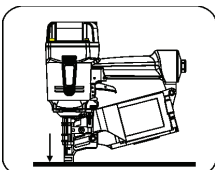

7. Pull the trigger and contact arm against the work-piece. (The tool must cycle)

TOOL OPERATION

NAIL LOADING

Pull down door latch to swing door open.
Swing magazine cover open.

Move up or down the nail support by pull up and twist to change setting.

The nail support should be adjusted correctly to the position indicated in inches or millimeters inside magazine.

Place a coil of nails into the magazine. Uncoil nails to reach the feed pawl, and place the second nail between the teeth on the feed pawl. Ensure nail heads fit in slot on the nose.

Swing magazine cover and door closed. Ensure the latch engages.

TOOL OPERATION

TEST OPERATION



Protect your eyes and ears. Wear Z87.1 safety glasses with side shields. Wear hearing protection. Employers and users are responsible for ensuring the user or anyone near the tool wears this safety protection.

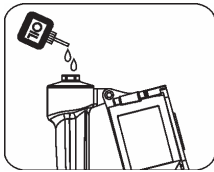

Add a few drops of lubricant, such as UNOCAL RX22, into the air inlet. Install a quick connect fitting to the tool.

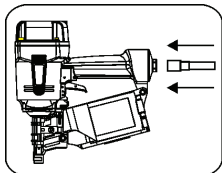

Connect the tool to an air compressor using a 3/8" I.D. hose which has a rated working pressure exceeding 13.8bar (200 psi) and a female quick coupler.

Regulate the air pressure at 5 bar (70 psi) and connect the air supply.

Check the operation of the safety yoke mechanism following the instructions of

Load fasteners following the instruction of loading the tool.

Adjust for proper fastener penetration of wood by regulating the air pressure as much as the lowest possible according to the diameters and length of fastener and the hardness of wood.

TOOL MAINTENANCE

WARNING

USE A 3-PIECE AIRSET

Failure to use a 3-piece airset allows the moisture and dirt inside compressor to go through into the tool directly. Wear and rust may be caused and perform poorly.

USE RECOMMEND OIL

Place 2 or 3 drops of spindle oil, UNOCAL RX22, into air inlet. If in-line oiler is used, manual lubrication through the air is not required daily.

INSPECT AND MAINTAIN DAILY OR BEFORE OPERATION

DRAIN AND CLEAN AIR LINE FILTER AND COMPRESSOR

KEEP LUBRICATOR FILLED IN AIR 3-PIECES SET

TIGHTEN ALL SCREWS AND KEEP CONTACT ARM MOVING SMOOTHLY

STORING

- (1) Keep the tool in a warm and dry area.
- (2) Keep out of reach of children.
- (3) Apply a thin coat of lubricant to the tool for storing.
- (4) All quality tools will eventually require serving or replacement of parts because of wear from the normal use.

Troubleshooting/Repairs

WARNING

Serious injury could occur if followed problems happen. The troubleshooting and/or repairs must be carried out only by the Apach Co. LTD qualified specialists or an authorized service center only.

Problem	Cause	Repair
Slow to cycle	Tool dry, lacks lubrication	Use Air Tool Lubricant
	Low air pressure	Check air supply equipment
	Exhaust port blocked	Check bumper, head valve spring, muffler
	Dirt on driver assembly	Disassemble nose and to clean
	Cylinder sleeve not seated correctly on bottom bumper	Disassemble to correct
	Cap spring broken	Replace cap spring
	O-rings or seal worn or damaged	Replace O-rings or seal
	Trigger assembly worn or damaged	Replace trigger assembly
Cycle failure	Air supply unsuccessfully	Check air supply equipment
	Tool dry, lack of lubrication	Use Air Tool Lubricant
	Head valve piston stuck	Disassemble, check and lubricate
	Cap spring broken	Replace cap spring
	Head valve O-rings worn or damaged	Replace O-rings

Troubleshooting/Repairs

Problem	Cause	Repair
Air leaking at cap	Loose screws	Tighten and recheck
	Seal or gasket worn or damaged	Replace gasket or seal
	Head valve bumper worn or damaged	Replace bumper
Air leaking at nose	Loose screws	Tighten and recheck
	Bumper worn or damaged	Replace bumper
	O-rings worn or damaged	Replace O-rings
Air leaking at trigger valve assembly	Spring worn or damaged	Replace spring
	O-rings worn or damaged	Replace O-rings
Fasteners jam in tool	Fasteners bent or wires broken	Remove and use another
	Fasteners specification wrong	Use only recommended fasteners
	Loose magazine/nose screws	Tighten all screws
	Driver channel worn	Replace nose/check door
	Driver broken	Replace driver
Fasteners skip	Tool dry, lacks lubrication	Use Air Tool Lubricant
	Fasteners specification wrong	Use only recommended fasteners
	Loose magazine nose screws	Tighten all screws
	Head cap gasket leaks air	Tighten screws or replace gasket
	Low air pressure	Check air supply system
	Magazine dry or dirty	Clean or lubricate

Troubleshooting/Repairs

Problem	Cause	Repair
Fasteners skip	Bumper worn or damaged	Replace bumper
	Dirt in driver channel	Disassemble and clean nose and driver
	Quick connector leaks air	Replace quick connect fittings
	Pusher spring damaged	Replace spring
	Piston O-ring worn or damaged	Replace O-ring, check driver
	Trigger valve O-rings worn or damaged	Replace O-rings
	Driver broken	Replace driver
Coil nailers Fasteners jam or skip	Feed piston dry	Lubricate in hole in feed cover
	Nail support not set correctly	Set nail support for length of being used
	Check Pawl binding	Inspect pawl and spring on door work freely
	Feed piston O-rings worn or damaged	Replace O-rings and check spring
	Magazine worn	Replace magazine

176 Industrial 9th Rd., Tali City Taichung County,
Taiwan 412

Tel: +886-4-24915576 Fax: +886-4-2491-5580
www.apach.com.tw info@apach.com.tw



M010002A-06/07



The content of this manual might be changed without notice for improvement.